

650V N-Channel Multi-EPI Super-JMOSFET

General Description

This Power MOSFET is produced using Silkor's advanced Superjunction MOSFET technology. This advanced technology has been especially tailored to minimize on-state resistance, provide superior switching performance, and withstand high energy pulse in the avalanche and commutation mode. These devices are well suited for high efficiency switched mode power supplies.

Features

- 15A, 650V, $R_{DS(on)typ} = 0.28\Omega @ V_{GS} = 10V$
- Low gate charge (typical 19.6nC)
- High ruggedness
- Fast switching
- 100% avalanche tested
- Improved dv/dt capability

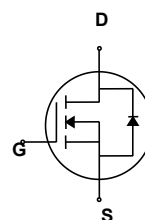

Absolute Maximum Ratings

$T_C = 25^\circ\text{C}$ unless otherwise noted

Symbol	Parameter	SL15N65CD	Units
V_{DSS}	Drain-Source Voltage	650	V
I_D	Drain Current - Continuous ($T_C = 25^\circ\text{C}$) - Continuous ($T_C = 100^\circ\text{C}$)	15	A
		8	A
I_{DM}	Drain Current - Pulsed (Note 1)	37.5	A
V_{GSS}	Gate-Source Voltage	± 30	V
EAS	Single Pulsed Avalanche Energy (Note 2)	711	mJ
I_{AR}	Avalanche Current (Note 1)	3.0	A
E_{AR}	Repetitive Avalanche Energy	1.11	mJ
dv/dt	Peak Diode Recovery dv/dt (Note 3)	20	V/ns
	MOSFET dv/dt	100	
P_D	Power Dissipation ($T_C = 25^\circ\text{C}$) - Derate above 25°C	111	W
		0.88	W/ $^\circ\text{C}$
T_J, T_{STG}	Operating and Storage Temperature Range	-55 to +150	$^\circ\text{C}$
T_L	Maximum lead temperature for soldering purposes, 1/8" from case for 5 seconds	300	$^\circ\text{C}$

* Drain current limited by maximum junction temperature.

Thermal Characteristics

Symbol	Parameter	SL15N65CD	Units
$R_{\theta JC}$	Thermal Resistance, Junction-to-Case	1.13	$^\circ\text{C}/\text{W}$
$R_{\theta JS}$	Thermal Resistance, Case-to-Sink Typ.	--	$^\circ\text{C}/\text{W}$
$R_{\theta JA}$	Thermal Resistance, Junction-to-Ambient	62.5	$^\circ\text{C}/\text{W}$

Electrical Characteristics

$T_C = 25^\circ\text{C}$ unless otherwise noted

Symbol	Parameter	Test Conditions	Min	Typ	Max	Units
Off Characteristics						
BV _{DSS}	Drain-Source Breakdown Voltage	$V_{GS} = 0\text{ V}, I_D = 250\text{mA}$	650	--	--	V
		$V_{GS} = 0\text{ V}, I_D = 0.25\text{uA}, T_J = 150^\circ\text{C}$	650	--	--	
I _{DSS}	Zero Gate Voltage Drain Current	$V_{DS} = 600\text{ V}, V_{GS} = 0\text{ V}$	--	--	1	uA
		$V_{DS} = 480\text{ V}, T_C = 125^\circ\text{C}$	--	2	--	uA
I _{GSSF}	Gate-Body Leakage Current, Forward	$V_{GS} = 30\text{ V}, V_{DS} = 0\text{ V}$	--	--	100	nA
I _{GSSR}	Gate-Body Leakage Current, Reverse	$V_{GS} = -30\text{ V}, V_{DS} = 0\text{ V}$	--	--	-100	nA

On Characteristics

V _{GS(th)}	Gate Threshold Voltage	$V_{DS} = V_{GS}, I_D = 250\text{uA}$	2.5	--	4.5	V
R _{DS(on)}	Static Drain-Source On-Resistance	$V_{GS} = 10\text{ V}, I_D = 7.5\text{ A}$	--	238	280	mΩ
R _g	Gate resistance	F=1MHZ	--	1.1	--	Ω

Dynamic Characteristics

C _{iss}	Input Capacitance	$V_{DS} = 400\text{ V}, V_{GS} = 0\text{V},$ $f = 1\text{MHz}$	--	780	--	pF
C _{oss}	Output Capacitance		--	23	--	pF
C _{o(tr)}	Time Related Output Capacitance	$V_{DS} = 0\text{V to } 400\text{ V}, V_{GS} = 0\text{ V}$	--	300	--	pF
C _{o(er)}	Energy Related Output Capacitance		--	37	--	pF

Switching Characteristics

t _{d(on)}	Turn-On Delay Time	$V_{DS} = 400\text{ V}, I_D = 5.3\text{A}$ $V_{GS} = 10\text{ V}, R_G = 10\ \Omega$ See Figure 13	--	7.6	--	ns
t _r	Turn-On Rise Time		--	6.7	--	ns
t _{d(off)}	Turn-Off Delay Time		--	38.2	--	ns
t _f	Turn-Off Fall Time		--	8.4	--	ns
Q _g	Total Gate Charge	$V_{DS} = 400\text{ V}, I_D = 5.3\text{A},$ $V_{GS} = 10\text{ V}$	--	19.6	--	nC
Q _{gs}	Gate-Source Charge		--	3.7	--	nC
Q _{gd}	Gate-Drain Charge		--	9.7	--	nC

Drain-Source Diode Characteristics and Maximum Ratings

I _S	Maximum Continuous Drain-Source Diode Forward Current	--	--	12.5	A	
I _{SM}	Maximum Pulsed Drain-Source Diode Forward Current	--	--	37.5	A	
V _{SD}	Drain-Source Diode Forward Voltage	$V_{GS} = 0\text{ V}, I_S = 5.3\text{A}$	--	--	1.2	V
t _{rr}	Reverse Recovery Time	$V_{DD} = 400\text{ V}, I_S = 5.3\text{A},$ $di_F / dt = 100\text{ A/us}$	--	234	--	ns
Q _{rr}	Reverse Recovery Charge		--	2.2	--	uC

※Notes:

1. Repetitive rating: pulse-width limited by maximum junction temperature.
2. $L = 79\text{mH}, I_{AS} = 3\text{ A}, R_G = 25\ \Omega$, starting $T_J = 25^\circ\text{C}$.
3. $I_{SD} \leq 5.3\text{ A}, di/dt \leq 100\text{ A/us}, V_{DD} \leq 400\text{ V}$, starting $T_J = 25^\circ\text{C}$.

Typical Characteristics

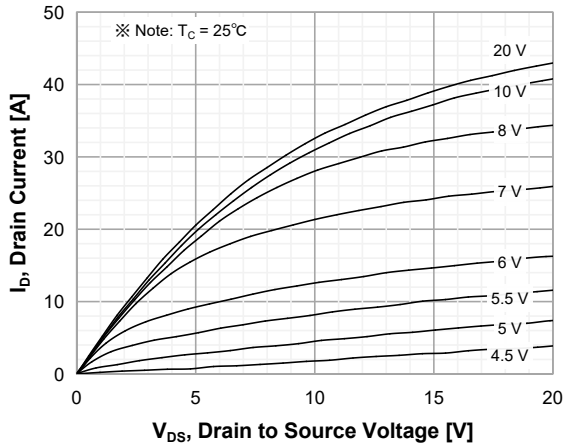

Figure 1. On-Region Characteristics

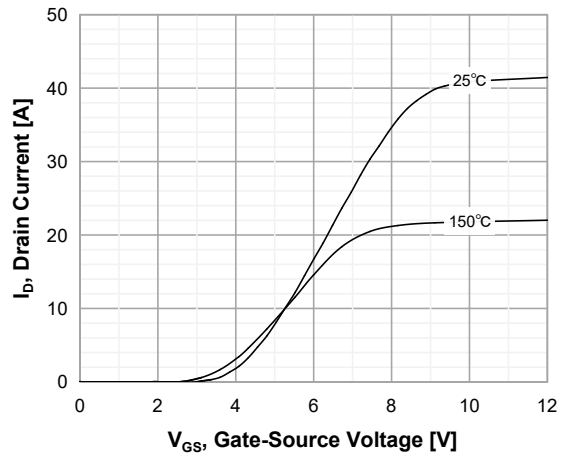

Figure 2. Transfer Characteristics

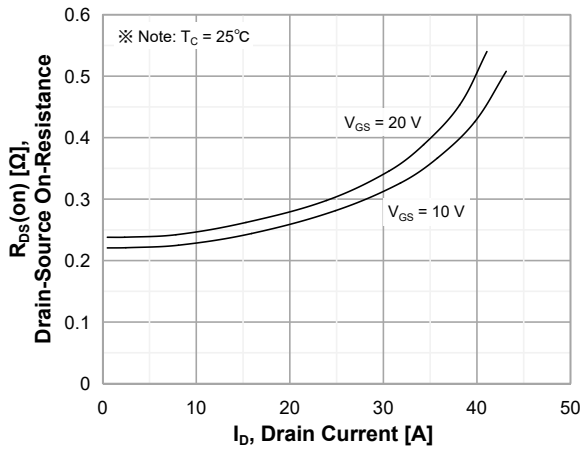

Figure 3. On-Resistance Variation vs Drain Current and Gate Voltage

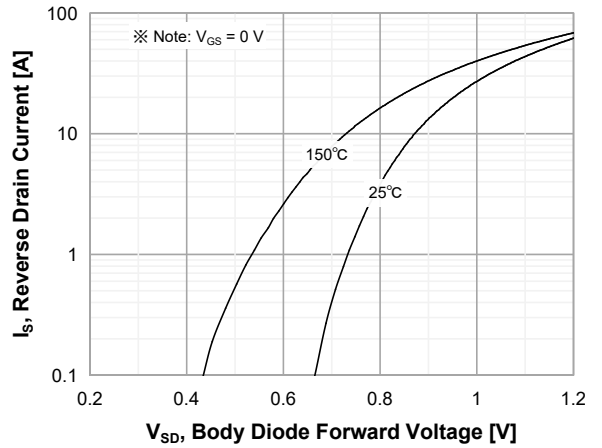

Figure 4. Body Diode Forward Voltage Variation with Source Current and Temperature

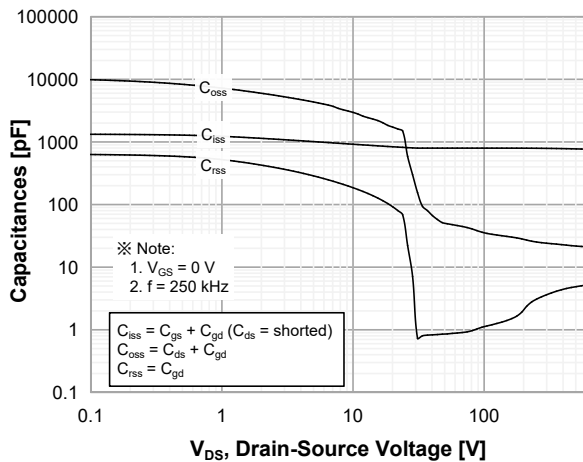

Figure 5. Capacitance Characteristics

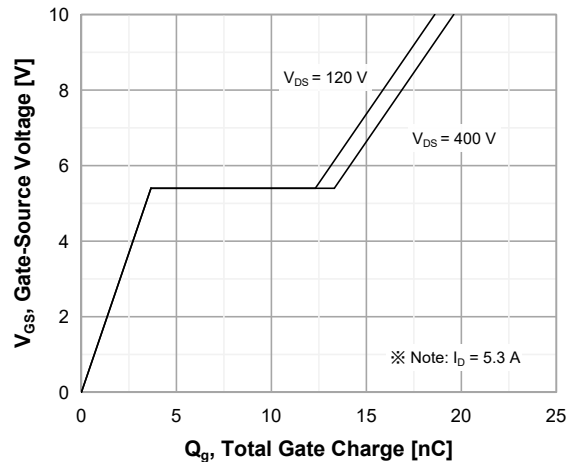

Figure 6. Gate Charge Characteristics

Typical Characteristics (Continued)

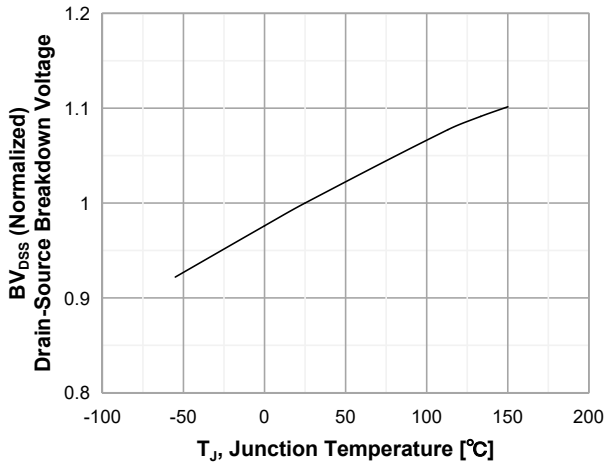

Figure 7. Breakdown Voltage Variation vs Temperature

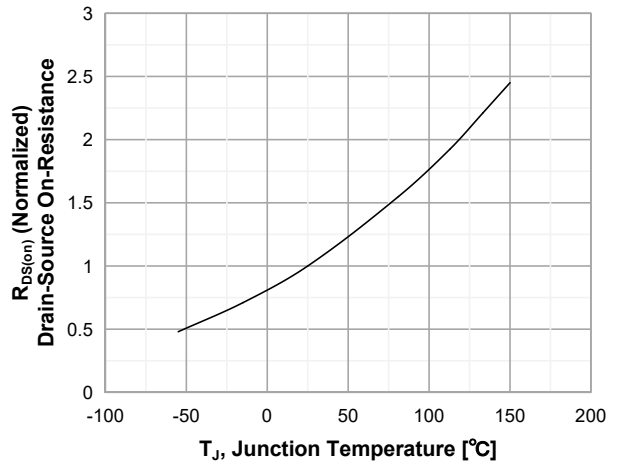

Figure 8. On-Resistance Variation vs Temperature

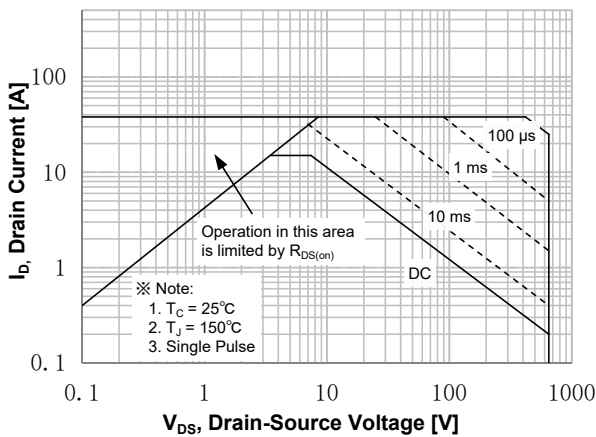

Figure 9. Maximum Safe Operating Area

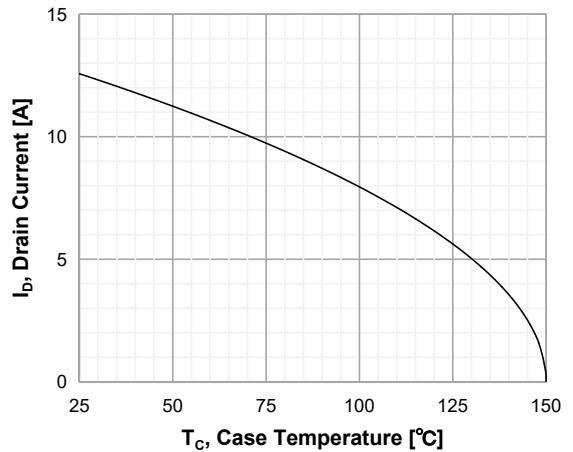

Figure 10. Maximum Drain Current vs Case Temperature

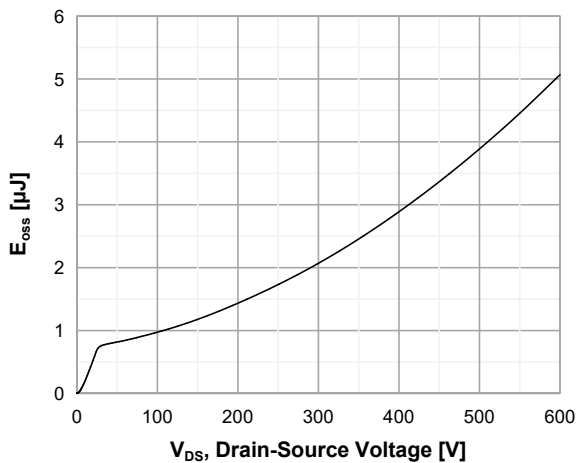

Figure 11. E_{OSS} vs. Drain to Source Voltage

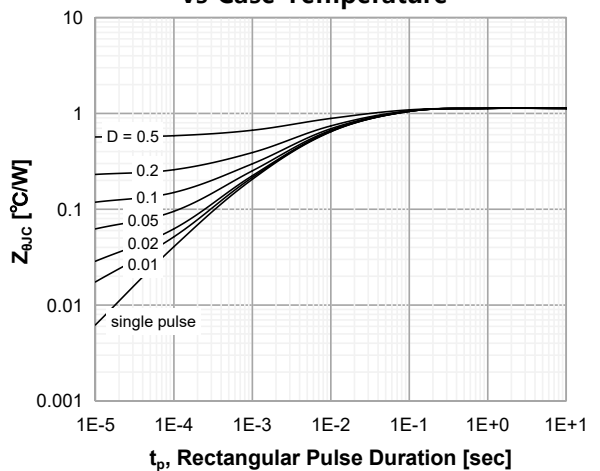
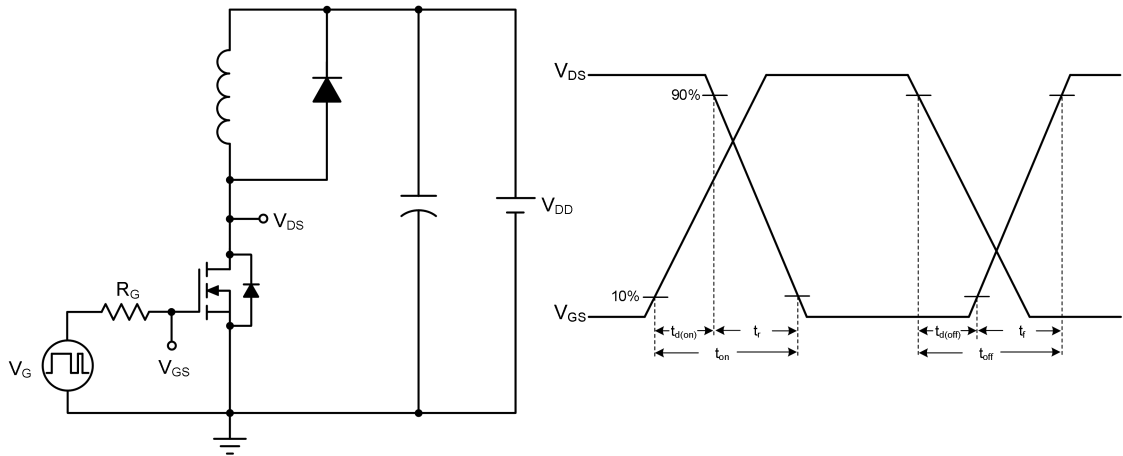
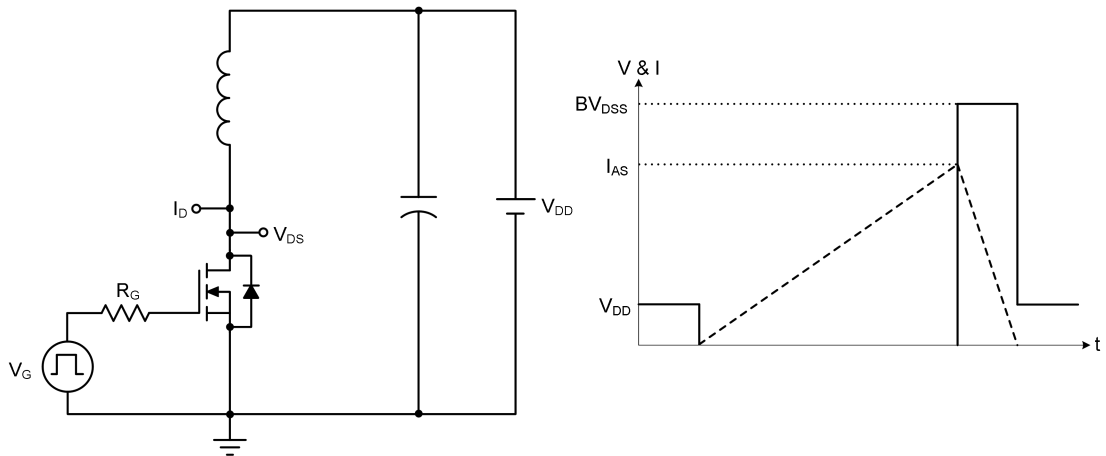

Figure 12. Transient Thermal Response Curve

Inductive Load Switching Test Circuit and Waveforms



Unclamped Inductive Switching Test Circuit and Waveforms



Peak Diode Recovery dv/dt Test Circuit and Waveforms

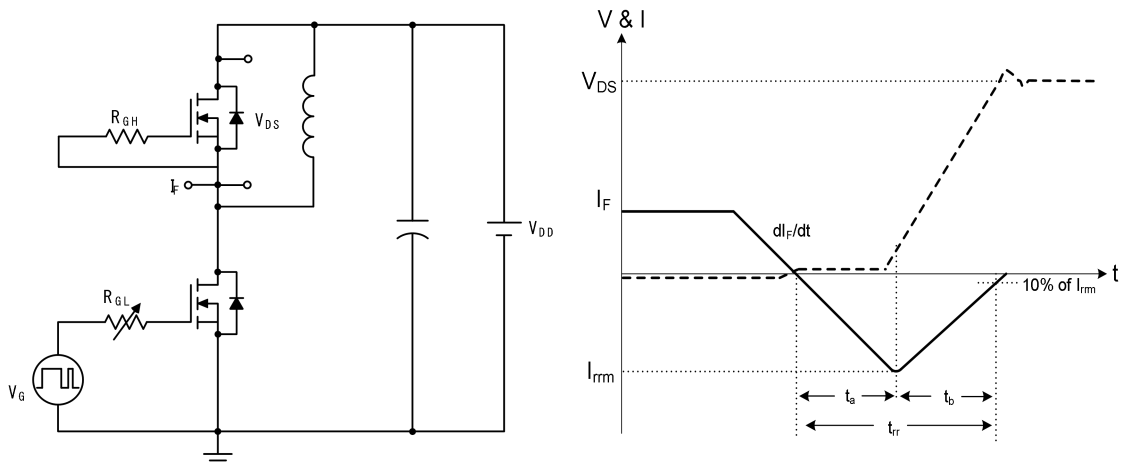

TO-252 OUTLINE

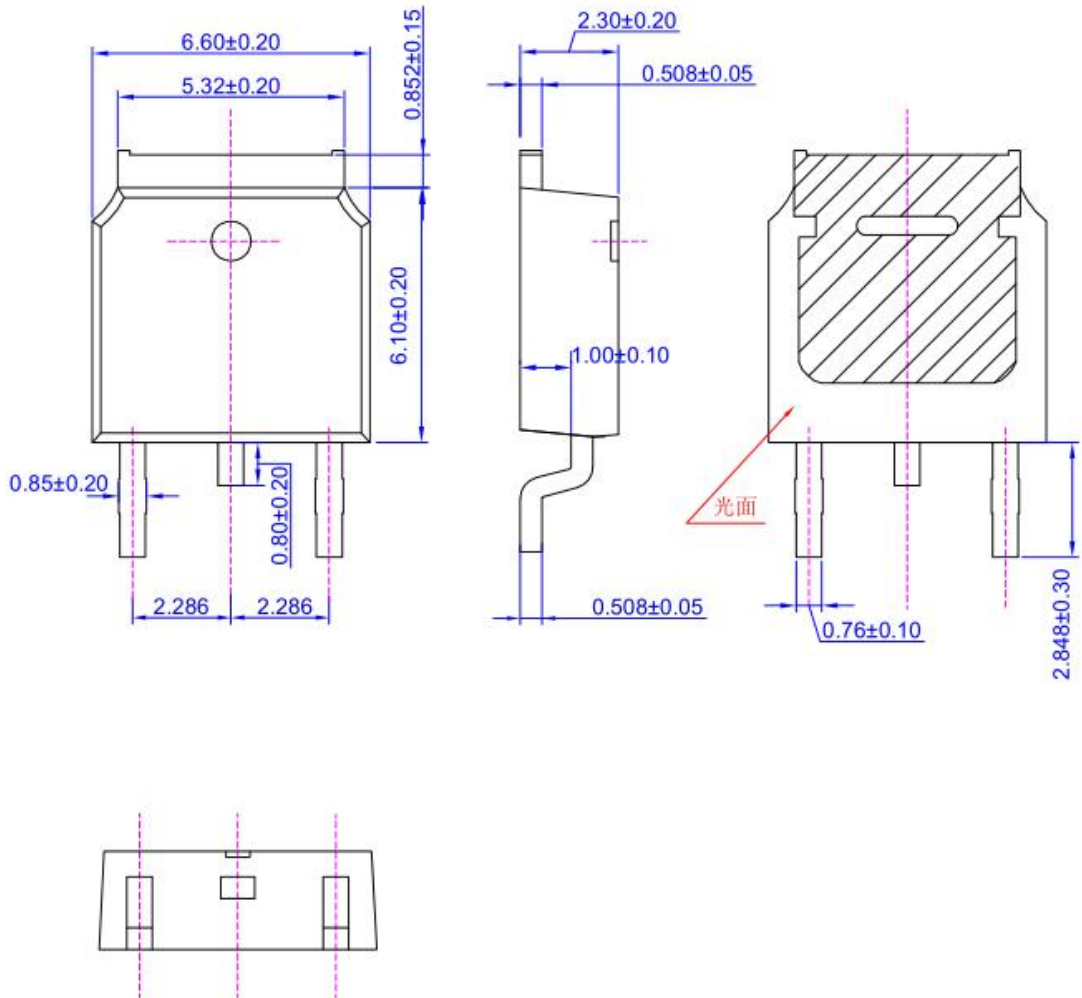

NOTE:

- 1The plastic package is not marked as smooth surface $Ra=0.1$; Subglossy surface $Ra=0.8$
- 2.Undeclared tolerance ± 0.25 , Unmarked fillet $R_{max}=0.25$